

SMART SOLUTIONS FROM ENVIROSPEC.COM

PowerWash Pro

Oil Field, Mining & Jetting Equipment

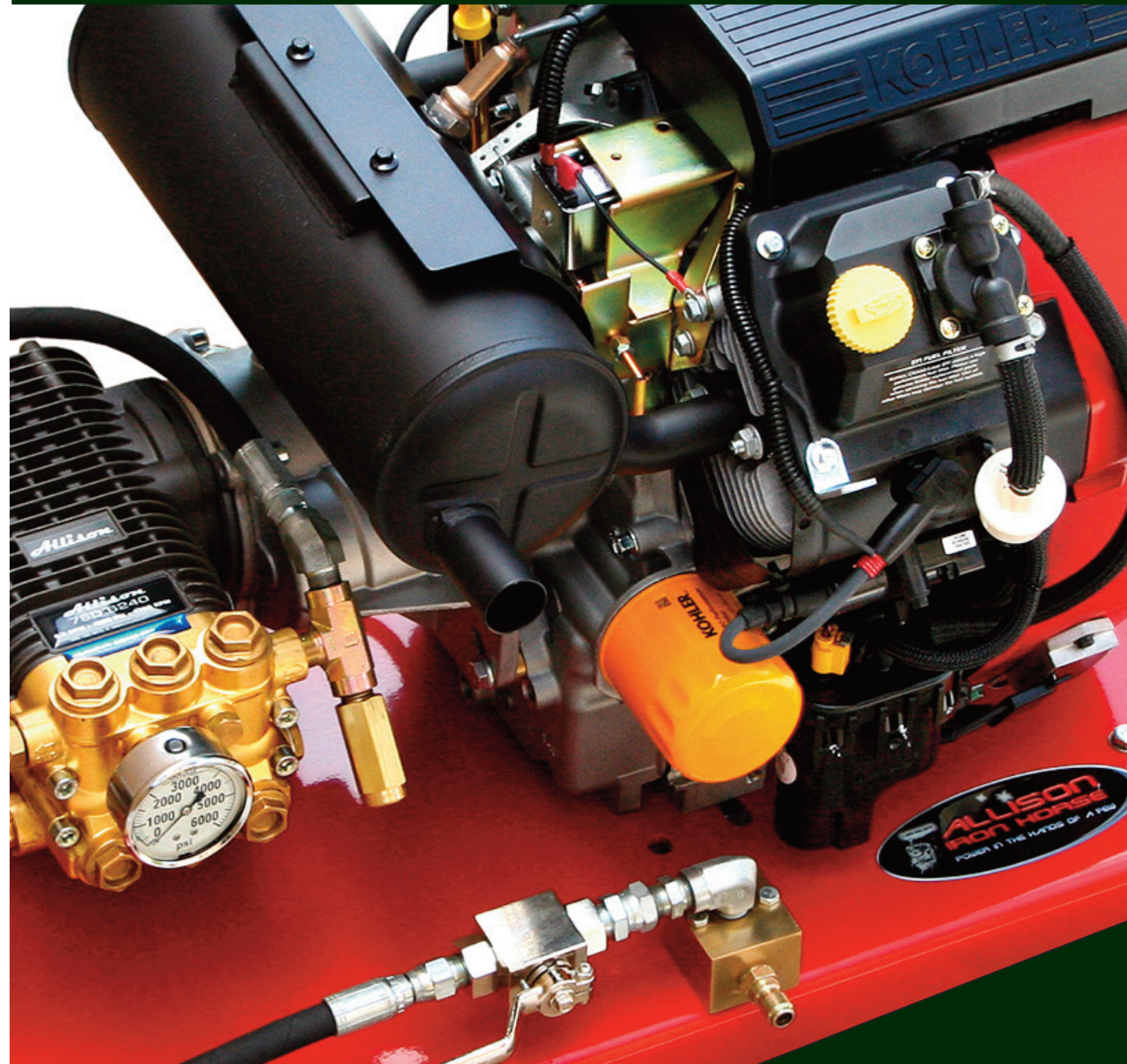

TABLE OF CONTENTS

Back Pack Sprayer	10	Generators	4	Pulleys & Bushings	16
Ball Valves	21	Guns, Trigger	5	Pump Rebuild CD	2
Base Plates	27	Gutter Sweep	11	Pumps, Hi-Pressure	13
Battery Box	24	Hi-Limit Switch	23	Pumps, Low Press. Chem	17
Battery Terminals	24	Hose, Hi-Pressure	7	Quick Connects	10
Brushes	9	Hose, Jumper	12	Quick Drain Oil Plug	25
Burners & Parts	22	Hose, Reel & Chem	20	Rails, Pump	2
Carts, Equipment	27	Hose, Tank to Machine	20	Rain Gear	20
Chem Shooters	15	Hour Meter-Tach	25	Reels	12
Chemical Induction	15	Ignitor, Bruner	23	Safety Relief Valve	26
Chlorine Pumper	16	Injectors, Chemical	14	Sand Blast Nozzles	24
Clamps, Hose	4	Insulation, Coil	22	Sewer Jetting Valves	2
Clutch, Pump	16	Key Switch	24	Sewer Nozzles	20
Coils, Burner	22	Key Way Stock	24	Sight Glass, Pump	2
Dip Stick	2	Lances	8	Sludge Sucker	24
Drum Accessories	4	Metering Valves	21	Soot Remover	22
Easy Start Valve	26	Motor, Burner	23	Spray-Flex Wand	11
Engines	25	Mounting Block	3	Starter Solenoid	25
Filter, Burner	22	Nozzle Holders	20	Surface Spinners	20
Filters, Chemical	15	Nozzle, Burner	22	Swivels, Hose Reel	12
Filters, Engine	25	Nozzle, Hi-Lo	7	Tachometer	25
Filters, Hi-Pressure	6	Nozzles, Ceramic	19	Tank, Gas-Diesel	24
Filters, Water	11	Nozzles, Hi-Pressure	18	Tape, Teflon/Electrical	21
Float Valve/Tank	11	Nozzles, Long Distance	19	Telescoping Wand	8
Flow Meters	26	Nozzles, Low Pressure	19	Tester, Pressure	2
Flow Switch	23	Oil, Pump	2	Thermal Valve	26
Foam Generators	14	O'rings for Valve Caps	2	Thermostat, Burner	22
Frames	27	Packing Tools	2	Thread Locker	21
Fuel Line	24	Poles, Extension	9	Thruster, Distance Nozzle	15
Fuel Pump, Burner	23	Pressure Switch	23	Transformer, Burner	23
Funnels	4	PRESSURE WASHERS		Throttle Cable	24
Garden Hose Assy.	11	- Cold Water Gas Eng	29	Trigger Guns	5
Gauge Port Valve Cap	2	- Cold Water Diesel	26	Trigger Guns, Low Press	17
Gauges, Hi-Pressure	2	- Exhaust Hood Sys.	26	Turbo Nozzles	6
Gear Reducers	16	- Hot Box Heaters	26	Unloaders	3
		- Hot Water Gas Eng	28	Vac Switch	23
				Wheels	27

2013 \$110,000 to operate our privately owned Animal Sanctuary



MILITARY VETERANS
SAVE AN ADDITIONAL 10%

Bonus Buck\$
10% of every purchase
THIS MONTH
can be used towards purchases **NEXT MONTH**

National POW/MIA Recognition Day
September 20, 2013



Keeping the Promise
www.dtic.mil/dpmo

Giving Back
is really what we do best!

Over the last 10 years EnviroSpec, on behalf of it's customers, has given back to communities everywhere in excess of

2 MILLION DOLLARS

2013 \$10,000 to K-9's for Warriors



2012 EnviroSpec donates \$5,000.00 & \$20,000 to our Shriner Hospital Kids



2013 \$25,000 for the Jekyll Island Spay/Neuter program





PRESSURE GAUGES

Bottom Mount
 #1130 3,600 PSI
 #1131 4,500 PSI
 #1132 6,000 PSI
 #1133 10,000 PSI

Back Mount
 #1132B 6,000 PSI

PRESSURE TESTER

- Connects between Unloader & Hose

#4505 Body Only - no gauge
 #4506 Tester with Gauge

PUMP HEAD TESTER

- Remove the unloader and plumb this tester into the high pressure side of the pump. Install the correct pressure nozzle and start engine. Read your gauge to determine exact pump pressure.

#1229

PACKING EXTRACTOR

- Complete set - for all pumps
- Includes slide hammer, 15, 18, 20, 22 & 24 mm sockets

#1007

PACKING SAVER

- SHUTS-DOWN ENGINE if pump head overheats when you forget to pull the trigger to allow cool water to enter the head

Screw into pump port. Attach black to ground & white to low oil shutdown wire

#TET-101

AL-607

- Pressure Actuated
- Up to 4,500 PSI
- Up to 8 GPM
- 3/8" FPT Inlet
- 3/8" MPT Outlet

#1104 W/Out Knob
 #1114 With Knob

AL-607-P

- Pressure Actuated
- Up to 4,500 PSI
- Up to 10.5 GPM
- 3/8" FPT Inlet
- 3/8" MPT Outlet

#3111

K-7 FLOW ACTUATED

- Up to 3,500 PSI
- 3/8" FPT Inlet/Out
- Zero Surge By-pass

#1089 - 2.1 to 2.9 GPM
 #1090 - 2.9 to 4.2 GPM
 #1091 - 4.2 to 6.6 GPM
 #1092 - 6.6 to 10.8 GPM

PACKING INSERTION KIT

- The easy way to replace worn packings

#1063

PUMP DIP STICKS

#5201 A-R XW & RW Series
 #5203 A-R RK Series
 #5103 Comet TW Series
 #5104 Comet RW & ZWD Series
 #1881 Cat 2SF/4SF/2DX
 #1880 Cat 5DX/66DX/5CP
 #1882 General Pumps

PUMP RAILS

- Engineered specifically for pump being powered by gas or diesel engines.

#1653

K-9

- Flow Actuated
- Up to 5,800 PSI
- Up to 13.2 GPM
- 1/2" In, Out, By-pass

#1093

K-10

- Flow Actuated
- Up to 3,600 PSI
- 3/8" FPT Inlet
- 3/8" MPT Outlet
- Gentle Start-up

#1096

VB-10

- Compensating Soft Touch
- Up to 3,800 PSI
- Up to 8 GPM
- 3/8" FPT Inlet
- 3/8" MPT Outlet
- Gentle Start-up

#1108

GAUGE VALVE CAP

- For mounting the gauge on the pump. Replace 1 HP Valve Cap with this one.

#1060 For GP / 'EZ' Pumps
 #1061 For GP / 'TS & T' Pumps

PUMP OIL

#1066 Comet, 1-32 oz. bottle
 #1064 General, 6-16 oz. bottles
 #1065 General, 24-16 oz. bottles
 #4788 Cat, 1-21 oz. bottle

PUMP REBUILD VIDEO

- With this you can rebuild ANY PUMP!

#GPV-101

VB-350

- Pressure Actuated
- Up to 5,650 PSI
- Up to 10.5 GPM
- 3/8" FPT Inlet
- 3/8" MPT Outlet

#2032

YU-2140

- Green Spring
- Up to 21 GPM
- Up to 4100 PSI

#1101

YU-2848

- Dual Gun Upgrade from YU2140
- Green Spring
- Up to 28 GPM
- Up to 4800 PSI

#YU2848

PUMP SIGHT GLASS

#5202 A-R XW, RW, RK, RKV Series
 #5101 COMET TW, RW Series
 #5102 COMET ZWD Series
 #1689 GP TS & T Series
 #1421 GP General TSF Series
 #92241 CAT (All except 60 series)

SEWER JETTING VALVES

#1004 For GP 'TT' Pumps
 #1005 For GP 'EZ' Pumps
 #1006 For GP 'T' & 'TS' Pumps
 #3340 For GP 'TSF' Pumps

VALVE CAP O'RINGS

- 6 required for 3-piston pump

#5210 A-R XW Series
 #5211 A-R RW & RKV Series
 #5110 Comet TW & TWS Series
 #5111 Comet RW, RWS & ZWD Series
 #5100 GP TS & T Series
 #5310 GP EZ Series
 #5311 GP TSF Series

YU-831

- Pressure Actuated
- Up to 4,000 PSI
- Up to 8 GPM
- 3/8" FPT Inlet
- 3/8" MPT Outlet

#YU831

PULSAR

- Pressure Actuated
- Up to 4,000 PSI
- Up to 8 GPM
- 3/8" FPT Inlet
- 3/8" MPT Outlet

#1099

MOUNTING BLOCKS

- Take the load off the pump head by remote mounting the unloader.

#1081 3/8" x 3/8"
 #1082 3/8" x 1/2"
 #1083 1/2" x 1/2"

GP-UNLOADER SET

- Pressure Actuated
- Up to 3,650 PSI
- Up to 8.0 GPM
- Fits 47, EZ & TX Pumps

#1110 Without Injector
 #1112 With Injector

A-R UNLOADER SET

- Pressure Actuated
- Mini for XT & XW Pumps
- Gymatic for XM & RK Pumps
- Gymatic for XW & RK Pumps over 5.0 to 4,000 PSI

#3072 Gymatic - No Inj.

BY-PASS HOSE

- This 800 PSI hose is the recommended hose for by-passing back to a water tank (open loop) or back to the inlet side of the unloader (closed loop)

#3399 sold p/f for flows to 10 GPM
 #3400 sold p/f for flows 10-25 GPM



SIPHON PUMPS

- Pumps 7 GPM

#686E
55 Gal. Extreme Duty

#686H
55 Gal. Heavy Duty

#696P
5 Gal. Pail Pump



DRUM VENT

- Allows air to enter drum as product is being removed

#686830



DRUM FAUCETS

- 3/4" & 2" plastic faucets for 55 gal. drums

#118407
3/4" Faucet

#686067
2" Faucet



DRUM FUNNELS

- Fits 2" bungs on 55 and 30 gallon drums
- The cover keeps contamination out

#2660 Funnel only

#2664 Cover

#686798 Funnel w/cover



LARGE PLASTIC FUNNEL

- Large capacity funnel w/ filter screen

#686764



DISPOSABLE FUNNELS

- Designed specifically for changing oil on: Pumps, Gears & Engines

#686790 32 oz.
36 Count (for Engines)

#686791 8.5 oz.
36 Count (for pumps/gears)



PAIL LID REMOVER

- Safely remove lids from buckets

#1652



DRUM WRENCH

- Fits all 55 gallon drum bungs

#686169



METAL DRUM FAUCET

- 3/4" push-release faucet

#686081



CLIPS & CLAMPS

RUBBER CLIPS

Keep hose & large bundles of chem line or electrical wire & battery cables off the floor.

#95302 1/4"

#95304 3/8"

#95306 1/2"

#95310 3/4"

#95314 1.0"

#95318 1-1/4"

#95322 1-1/2"



HOSE CLAMPS

- Premium Series Clamps
- Corrosion Factor 1000'
- 316 Stainless Steel

#90014 1/4" to 9/16"

#90017 7/16" to 11/16"

#90024 5/8" to 15/16"

#90032 1" to 1-1/4"



WINCO GENERATORS

#1434 2,000 watts - 2-Bearing, Industrial 5/8" Shaft

#7101 2,400 watts - Brushless, 2-Bearing, Industrial 1.125" Shaft

#7102 4,000 watts - Brushless, 2-Bearing, Industrial 1.125" Shaft

#7103 6,000 watts - Brushless, 2-Bearing, Industrial 1.125" Shaft

#7104 7,200 watts - Brushless, 2-Bearing, Industrial 1.125" Shaft

#7105 8,000 watts - 2-Bearing, Industrial 1-1/4" Shaft

Replacement Parts:

#1435 BRUSH (3 REQUIRED)

#1436 RECEPTACLE (2 Required) for 2000 watt #1434 (for all other models call)

#1437 RECTIFIER (1 Required) for 2000 watt #1434 (for all other models call)

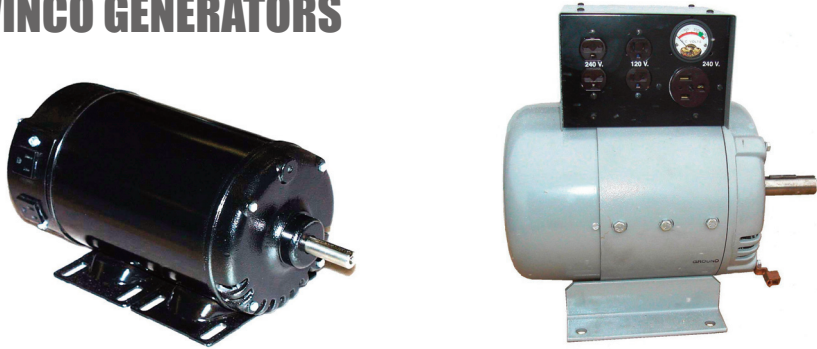

ALLISON YGA-5000

- Stainless Steel Ball
- 5,000 PSI
- Up to 12 GPM
- Up to 300°

#YGA5000 SS Ball

#YGA5000C with Chlorine Ball



ALLISON HI-TECH 5500

- Easy Pull
- Up to 5,500 PSI
- Up to 13 GPM
- Max Temp 300°

#HT5500 SS Ball

#HT5500C Chlorine Ball



ALLISON HI-TECH 501

- Easy Pull
- Up to 4,500 PSI
- Up to 8 GPM
- Max Temp 300°

#1209 SS Ball



ALLISON PL-5100

- Easy Pull
- Up to 5100 PSI
- Up to 12 GPM
- Max Temp 300°

#PL51 SS Ball

#PL51C Chlorine Ball



ALLISON HI-TECH 5000

- Easy Pull
- Up to 5000
- Up to 9 GPM
- Max Temp 300°

#1208 SS Ball



Allison Super Gun

- Easy Pull
- Up to 5,100 PSI
- Up to 11 GPM
- Max Temp 300°

#1003 SS Ball

#1014 Chlorine Ball



RL COMP GUN

- SUPER Easy Pull
- Up to 5,700 PSI
- Up to 13.2 GPM
- Max Temp 300°

#1204 4100 PSI to 13.2 GPM

#1206 5700 PSI to 8.0 GPM



ALLISON COMP GUN

- SUPER Easy Pull
- Up to 5,000 PSI
- Up to 10 GPM
- Max Temp 300°

#1230 SS Ball



YG-4500S

- Easy Pull
- Up to 5,000 PSI
- Up to 10 GPM
- Max Temp 300°

#1218 SS Ball



GUN WHIPS

- By installing this 4000 PSI whip you will be extending the life of the quick connect coupler by at least 10 times.

#1202 1' Whip

You will also need 1 each QS8FB Coupler



PA-RL31 (YG5000)

- Same as YG5000 & 5000C
- Up to 5,000 PSI
- Up to 11 GPM
- Max Temp 300°

#1220 SS Ball

#1221 Chlorine Ball



FRONT ENTRY GUN

- Up to 3000 PSI
- Up to 8 GPM
- Max Temp 300°

#1203 SS Ball



CHLORINE BALLS

- Rebuild your gun by using Ceramic Balls.

#1746 1/4"

#1747 5/16"

#1744 11/32"

#1745 13/32"

#1749 9/32"



NEW! Gun/Lance with built-in Nozzle Holder

Nozzle Holder

#8102

- 4,000 PSI, 8 GPM, 24" upgradable lance
- Holds 4 of your favorite nozzles
- Includes Side Grip Lance Handle



TRIGGERLESS GUN

- Up to 4100 PSI
- Up to 8.0 GPM
- Max Temp 300°

#1223 Triggerless



Voted the Industry's BEST Technical Web Site!

Place your order at www.envirospec.com



HYDRO-JET 4000

Noz	Size	Kit
#16221	2.5	#41374
#16222	3.0	#41375
#16223	3.5	#41376
#16224	4.0	#41377
#16225	4.5	#41378
#16226	5.0	#41379
#16227	5.5	#41380
#16228	6.0	#41381



HYDRO-JET 5000 PSI

Noz	Size	Kit	Noz	Size	Kit
#16284	3.0	#41482	#16289	5.5	#41487
#16285	3.5	#41483	#16290	6.0	#41488
#16286	4.0	#41484	#16291	6.5	#41489
#16287	4.5	#41485	#16292	7.0	#41490
#16288	5.0	#41486	#16293	7.5	#41491



SPLATTER SHIELD

- This 'splatter shield' attaches to any lance and covers the turbo nozzle so harsh chemicals and pressure do not come in contact with delicate surfaces.



#1497

ROTO-JET 3600

Noz	Size	Kit
#1547	3.0	#1569
#1548	3.5	#1570
#1549	4.0	#1571
#1550	4.5	#1572
#1551	5.0	#1573
#1552	5.5	#1574
#1553	6.0	#1575



ROTO-JET 4500

Noz	Size	Kit
#1562	4.0	#1584
#1563	4.5	#1585
#1564	5.0	#1586
#1565	5.5	#1587
#1566	6.0	#1588
#1567	7.0	#1589



ROTO-JET 5800

Noz	Size	Kit
#1554	4.0	#1576
#1555	4.5	#1577
#1556	5.0	#1578
#1557	5.5	#1579
#1558	6.0	#1580
#1559	7.0	#1581
#1560	8.0	#1582
#1561	12.0	#1583



DIRT KILLER 3200

Noz	Size	Kit
#1471	3.0	#1476
#1472	3.5	#1477
#1473	4.5	#1478
#1474	5.5	#1479
#1475	7.0	#1480



DIRT KILLER 4700

Noz	Size	Kit
#1481	3.5	#1489
#1482	4.0	#1490
#1483	4.5	#1491
#1484	5.5	#1492
#1486	7.0	#1494
#1487	8.0	#1495
#1488	10.0	#1496



ROTO-MAX 3500

- 3500 PSI Max
- Adjust from 0 to 15 degrees



#1498 2-3 GPM
#1499 3-4 GPM
#1500 4-6 GPM
#1501 Kit for RotoMax

STELLETO 5000

Noz	Size	Kit
#1965FN	3.0	#1966N
#1967FN	3.5	#1968N
#1969FN	4.0	#1970N
#1971FN	4.5	#1972N
#1973FN	5.0	#1974N
#1975FN	5.5	#1976N
#1977FN	6.0	#1978N
#1979FN	6.5	#1980N
#1981FN	7.0	#1982N



PA-5100

Noz	Size	Kit	Noz	Size	Kit
#2002	3.0	#2003	#2012	5.5	#2013
#2004	3.5	#2005	#2014	6.0	#2015
#2006	4.0	#2007	#2016	6.5	#2017
#2008	4.5	#2009	#2018	7.0	#2019
#2010	5.0	#2011	#2020	8.0	#2021



TURBO FILTERS

- Don't VOID your warranty on Turbos



#1509 1/4" MPT x 1/4" FPT
#1510 'QC' PLUG x 1/4" MPT (shown)
#1510F Replacement Screen

ALLISON - ECONOMY 2500 PSI

- For cold water equipment only.



Shown with optional plug

#5199 3.0 Nozzle Size
#5200 4.0 Nozzle Size

ALLISON - ECONOMY 4200 PSI

- Rated to 194 degrees



#5194 3.0 Noz Size
#5195 3.5 Noz Size
#5196 4.0 Noz Size
#5197 4.5 Noz Size
#5198 5.0 Noz Size

PA - Hi-Lo Nozzle

- Push for Soap
- Pull for Pressure



#4002	2.0 Noz
#4003	2.5 Noz
#4004	3.0 Noz
#1292	3.5 Noz
#1293	4.0 Noz
#1294	4.5 Noz
#1295	5.0 Noz
#1296	5.5 Noz
#1297	6.0 Noz
#1299	7.0 Noz
#1300	8.0 Noz

DIRT KILLER Hi-Lo

- 4300 PSI Push for Soap - Pull for Pressure



#1686	4.0 NOZZLE	RED DOT
#1687	4.5 NOZZLE	BLACK DOT
#1688	5.5 NOZZLE	BLUE DOT

HOSE - SERPENTINE #1 Power Wash Hose

- 3/8" Male Pipe Thread Swivel
- 3/8" Male Pipe Thread fixed
- Strain Reliefs on both ends

4,000 PSI - 1 WIRE

- BLACK

#B408-050	50'
#B408-075	75'
#B408-100	100'
#B408-150	150'
#B408-200	200'
#B408-250	250'



* Includes Quick Connects

ADJUSTABLE FAN TYPE

- Adjust from 0 to 65 deg. (no Hi-Lo feature)



#2055	3.0 NOZ
#2056	3.5 NOZ
#2057	4.5 NOZ
#2059	5.5 NOZ
#2060	6.5 NOZ
#2061	7.5 NOZ
#2062	8.0 NOZ

MOSMATIC EXHAUST HOOD SWIVEL

- FIXED NOZZLES

2 Nozzle	3-Nozzle		
#1519	3"	#1531	3"
#1520	6"	#1532	6"
#1521	12"	#1533	12"
#1522	16"	#1524	16"
#1523	20"	#1535	20"
#1524	24"	#1536	24"

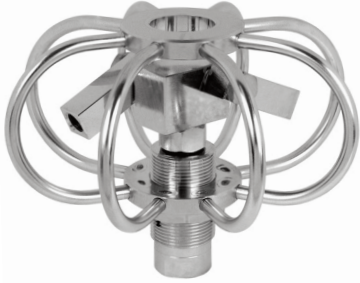

- GREY

#G408-050	50'
#G408-075	75'
#G408-100	100'
#G408-150	150'
#G408-200	200'
#G408-250	250'



* Includes Quick Connects

MTM Hi-Lo Nozzle

- Push for Soap - Pull for Pressure



#1602	3.0 NOZ
#1603	3.5 NOZ
#1604	4.5 NOZ
#2050	5.0 NOZ
#2051	5.5 NOZ
#2052	6.5 NOZ
#2053	7.5 NOZ
#2054	8.0 NOZ

POPULAR TANK BARBS

- ADJUSTABLE NOZZLES

2 Nozzle	3-Nozzle		
#1525	3"	#1537	3"
#1526	6"	#1538	6"
#1527	12"	#1539	12"
#1528	16"	#1540	16"
#1529	20"	#1541	20"
#1530	24"	#1542	24"



6,000 PSI - 2 WIRE

- BLACK

#B608-050	50'
#B608-075	75'
#B608-100	100'
#B608-150	150'
#B608-200	200'
#B608-250	250'



* Includes Quick Connects

- GREY

#G608-050	50'
#G608-075	75'
#G608-100	100'
#G608-150	150'
#G608-200	200'
#G608-250	250'



* Includes Quick Connects

POLY-BARB-STRAIGHT

#PB34S	3/4" Barb x 3/4" MPT
#PB10S	1.0" Barb x 1.0" MPT
#PB114S	1-1/4" Barb x 1-1/4" MPT
#PB112S	1-1/2" Barb x 1-1/2" MPT
#PB200S	2.00" Barb x 2.00" MPT



POLY-BARB 90° BEND

#PB34B	3/4" Barb x 3/4" MPT
#PB10B	1.0" Barb x 1.0" MPT
#PB114B	1-1/4" Barb x 1-1/4" MPT
#PB112B	1-1/2" Barb x 1-1/2" MPT
#PB200B	2.00" Barb x 2.00" MPT



HOSE - SERPENTINE 3,000 PSI x 1/2"

- 1/2" Male Pipe Thread Swivel
- 1/2" Male Pipe Thread fixed
- Strain Reliefs on both ends



#B302-050	50'
#B302-100	100'

HOSE - SERPENTINE 7,400 PSI x 3/8"

- Super Light Weight
- 3/8" Male Pipe Thread Swivel
- 3/8" Male Pipe Thread fixed
- Strain Reliefs on both ends



#B748-050	50'
#B748-100	100'



LANCES

PLATED • 1/4" WITH GRIP

- #1236 Straight, 12"
- #1237 Straight, 24"
- #1238 Straight, 36"
- #1242 15° Bent, 36"
- #1239 Straight, 48"
- #1243 15° Bent, 48"
- #1240 Straight, 60"
- #1244 15° Bent, 60"
- #1241 Straight, 79"
- #1245 15° Bent, 79"

STAINLESS • 1/4" WITH GRIP

- #1246 Straight, 24"
- #1247 Straight, 36"
- #1251 15° Bent, 36"
- #1248 Straight, 48"
- #1252 15° Bent, 48"
- #1249 Straight, 60"
- #1253 15° Bent, 60"
- #1250 Straight, 79"
- #1254 15° Bent, 79"

ALUMINUM, 1/4" W/GRIP

- #1354 24"

ALUMINUM, 1/4" NO/GRIP

- #1353 24"
- #1355 36"
- #1357 48"
- #1359 60"
- #1361 79"
- #1363 96"

* Freight on lances over 48" are costly to ship. Some lances over 48" will come as 2 lances with a lance coupler to achieve desired length. (see below)



DUAL LANCE

- 1/4" Pipes
- Best Lances when using an injector
- Rated to 4100 PSI



- #1262 42" Stainless Premium
- #1362 42" Zinc Plated Premium
- #1263 11" Stainless Lance
- #1264 27" Stainless Lance
- #1265 37" Stainless Lance

GENERAL DUAL LANCE

- **NOT GOOD** for chemical draw due to the 1/8" pipes.



- #1255 36"
- #1256 36" w/QC' Coupler
- #1257 72" w/QC' Coupler

DUAL DIVERTER LANCE

- Pull Trigger for Soap
- PSI: 3,600 / GPM: 10.5



#1235

FLEX-LA CE

- Great for fender wells, exhaust hoods, engines & boats



- #1795 Plated Steel 1/4" x 1/4" MPT
- #1796 Stainless Steel 1/4" x 1/4" MPT

LANCE ACCESSORIES



- #1612 Vented Grip for 1/4" lances
- #1260 Adjustable Slide Handle for 1/4" lances

DEEP SHOULDER COUPLER

If you need to couple two lances together you will need this coupler. The deep shoulders keep the lances from breaking at the threads.



#1258 1/4"

DEEP SHOULDER 'Quick Connects'

- Plugs:
#1021 Steel
#1023 Stainless
- Couplers:
#1022 Steel
#1024 Stainless



TELESCOPING LANCE - 18' to 24'

- The industry's best telescoping lance
- For those impossible to reach places



- #2018M 18'
- #2024M 24'

- #1814 Gutter Sweep
- #2028 'Load Bearing' Belt Harness

LONG DISTANCE NOZZLES for TELESCOPING WANDS

Laser Spray at 0°
Fan Spray up to 65°
with a simple twist!



VERY POPULAR

- #1365 4.0 Nozzle
- #1424 4.5 Nozzle
- #1440 5.0 Nozzle
- #1466 5.5 Nozzle
- #1590 6.5 Nozzle
- #1623 8.0 Nozzle

PROFESSIONAL POLES

Our Fiberglass and Aluminum Extension Handle is sure to meet and exceed your needs for a high quality, multiple application wash handle. The first tier of the handle is crafted with sturdy fiberglass to ensure strength and dexterity, while offering a sleek design with black ridged handles to prevent slipping in any wet environment. The second tier, which makes up the extension of the handle, is built with versatile aluminum to give the overall handle a lower weight to mass ratio; which, in turn, gives you more control and less weight up to 16 feet.



Using what for where?

- 4 footers
...are great for car lots
- 6 footers
...are great for tractors & brooms
- 8 & 10 footers
...are great for 1-story houses
- 12 footers
...are great for hi-cubes & straights
- 16 footers
...are great for houses & trailers

Length Part #

- 2 - 4 ft. 240FA
- 3 - 6 ft. 360FA
- 4 - 8 ft. 480FA
- 5 - 10 ft. 510FA
- 6 - 12 ft. 612FA
- 8 - 16 ft. 816FA

COUNTER DUSTERS

- Black Plastic Bristle made on a 13" plastic block. Sanitary Code Approved.
- 2-1/2" trim



#153ER1

FENDER BRUSHES

- These premium brushes are set in flagged yellow polystyrene bristle on 8" or 20" foam plastic blocks with a 2 1/2" trim.



- #215ER1 8" Handle
- #216ER1 20" Handle

SPECIALTY BRUSHES

10" BI-LEVEL

- Great for house siding and trailer bodies

#1457



10" BI-LEVEL - FINE FINISH

- Higher pile holds more water longer

#1456



GUTTER & STACK BRUSH

- For hard to clean house gutters and exhaust stacks on tractors

#1459



The Industry's ONLY Do-Everything Brush

10" FINE FINISH - 1/2 CIRCLE

This 'half-circle' brush has multiple pole entry positions which along with it's unique configuration and bristle technology.

#1458



BRUSHES

10" PREMIUM

- Ideally suited for tractor/trailers & houses

#1451



10" PREMIUM - FINE FINISH

- Ideally suited for paint jobs such as automobiles or high-end tractor/trailers

#1450



14" PREMIUM

- Ideally suited for tractor/trailers & houses

#1454



14" PREMIUM - FINE FINISH

- Ideally suited for paint jobs such as automobiles or high-end tractor/trailers

#1455



18" & 24" PREMIUM

- Ideally suited for trailers & houses (considered to large for tractors)

#1452 18"
#1453 24"



5-GAL BUCKET LIDS

- # 5-LNS without spout 'snap on-off'
- # 5-LWS With spout



Voted the Industry's BEST Technical Web Site!

Place your order at www.envirospec.com



BRECO COUPLERS

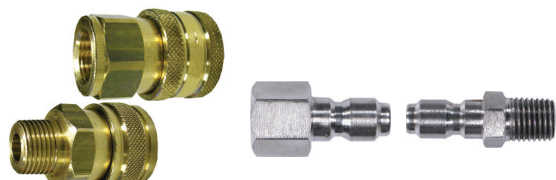

PLUGS

- #BC4F 1/4" FPT Inlet, 1/4" Out
- #BC4M 1/4" MPT Inlet, 1/4" Out
- #BC8F 3/8" FPT Inlet, 3/8" Out
- #BC8M 3/8" MPT Inlet, 3/8" Out

- #BP4F 1/4" FPT Inlet, 1/4" Out
- #BP4M 1/4" MPT Inlet, 1/4" Out
- #BP8F 3/8" FPT Inlet, 3/8" Out
- #BP8M 3/8" MPT Inlet, 3/8" Out

Brass Couplers



- #QS4FB 1/4" FPT Inlet, 1/4" Out
- #QS4MB 1/4" MPT Inlet, 1/4" Out
- #QS8FB 3/8" FPT Inlet, 3/8" Out
- #QS8MB 3/8" MPT Inlet, 3/8" Out

FILTER CONNECTORS



- #1019 1/2" MPT
- #1020 3/4" MPT
- #1625 Filter Washer Screen

CLEAR BOWL FILTER

- 50 Mesh



- #1012 1/2" In/Out
- #1013 3/4" In/Out

PREMIUM WATER FILTERS

- Allison 'Big Gulp' Filters won't starve and overwork your Pump.
- Extra large internal chamber
- Extra large ports for maximum flow
- Handles up to 22 GPM
- 50 mesh screen, 1" inlet/outlet



- #3798 3/4" Premium Water Filter
- #1015 1.0" Premium Water Filter
- #3799 1.0" Premium Water Filter w/ 'Quick' Clean-Out

TWIST COUPLERS

- Great of installing on Unloaders for easy servicing without having to find a wrench.



- #1937 1/4" FPT
- #1940 1/4" MPT
- #1943 3/8" FPT
- #1946 3/8" MPT

TWIST PLUGS



- #1925 1/4" FPT
- #1928 1/4" MPT
- #1931 3/8" FPT
- #1934 3/8" MPT

Stainless Couplers



- #QS4FS 1/4" FPT Inlet, 1/4" Out
- #QS4MS 1/4" MPT Inlet, 1/4" Out
- #QS8FS 3/8" FPT Inlet, 3/8" Out
- #QS8MS 3/8" MPT Inlet, 3/8" Out

GARDEN HOSE QUICK CONNECTS

- Industrial Quality
- Solid Brass Construction



- #1016 Plug
- #1017 Coupler
- #1018 Complete Set

DIRECT MOUNT FILTER

- Mounts directly to Pump Head
- 50 Mesh with brass with clear bowl

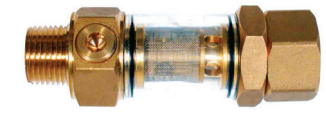

- #1011 with By-Pass Port

O'Ring Pick

- For removing o'rings from Check Valves & Quick Connects



- #1600 \$4.95

Hi-Heat Couplers

- To hot to handle? These couplers make it easier to disconnect hoses & accessories without burning your fingers.



- #1818 1/4" MPT
- #1817 1/4" FPT
- #1820 3/8" MPT
- #1819 3/8" FPT

Standard Plugs



- #QP4FB 1/4" FPT Inlet, 1/4" Out
- #QP4MB 1/4" MPT Inlet, 1/4" Out
- #QP8FB 3/8" FPT Inlet, 3/8" Out
- #QP8MB 3/8" MPT Inlet, 3/8" Out

GARDEN HOSE CONNECTORS



- #1309 Single Shut Off
- #1310 Dual Shut Off
- #1311 Dual Hose Connector

Y-TRAP PRE-FILTER

- This 50 mesh filter is best used between the tank and the secondary filter on the machine.



- #1157 3/4" In/Out
- #1158 1" In/Out

COMPACT FILTER

- 50 Mesh
- Mounts directly to Pump Head
- 1/2" In/Out with by-pass port



- #1009

LANCE COUPLERS

- Connect 2 lances together. The deep shoulders help to keep the lance from breaking at the threads.



Couplers:

- #1022 Steel
- #1024 Stainless

Plugs:

- #1021 Steel
- #1023 Stainless

'QC' O'rings



EPDM - 300 degree

- #QOR4E 1/4", 50 each
- #QOR8E 3/8", 50 each

VITON - 400 degree

- #QOR4V 1/4", 50 each
- #QOR8V 3/8", 50 each

Stainless Plugs



- #QP4FS 1/4" FPT Inlet, 1/4" Out
- #QP4MS 1/4" MPT Inlet, 1/4" Out
- #QP8FS 3/8" FPT Inlet, 3/8" Out
- #QP8MS 3/8" MPT Inlet, 3/8" Out

FLOAT TANK VALVE

- 3/4" Inlet
- Up to 145 PSI & 140 Degree



- #1599

FLOAT TANK VALVE

- Plastic 3/4" Inlet
- Up to 145 PSI & 140 Degree



- #1598

HUDSON FLOAT VALVE

- Our #1 Selling Float Valve
- No Moving Parts
- 1" FPT Inlet



- #1343 90 Degree Temp Rating
- #1344 150 Degree Temp Rating

11,000 PSI-550 DEGREE O'RINGS

- The best for HIGH heat and HARSH chems



- #QOR4X 1/4", 20 each
- #QOR8X 3/8", 20 each

HIGH HEAT O'RINGS 450 DEGREES



- #1960 1/4", 50 each
- #1961 3/8", 50 each

BACK-PAK SPRAYER



- 4-Gallon Capacity
- 2 Std Spray Tips
- 2 Bonus Tips
- Viton Seals

- #BPS-405

GUTTER SWEEP

This gutter clean-out tool attaches to the end of the lance & is a great 'add-on' service tool



- #1814 w/Std. Disconnects

SPRAY-FLEX LANCE

- Holds whatever shape you bend it to!

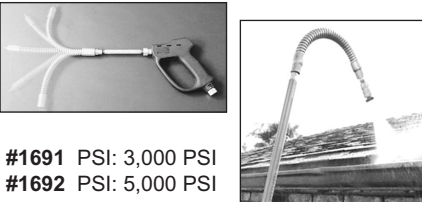

- #1691 PSI: 3,000 PSI
- #1692 PSI: 5,000 PSI

FLOAT TANK & FILTER

- Max Temp 140 Degree Temp Rating
- Measures 5" x 10" x 8"



- #1597 Tank
- #1234 Filter

Voted the Industry's BEST Technical Web Site!

Place your order at www.envirospec.com



TITAN U-FRAME



#TI1-3112
Reel, Crank, 12" - Powder Coated
#TI1-4812
Reel, Crank, 12" - Aluminum

ALLISON REELS



- The Industry's Best Hose Reel Value!
- Solid Steel Construction
- Durable Powder Coat
- Direct Hand Crank Rewind
- Full Flow Swivel Brass Joint
- 5,000 PSI Rated, 3-1 Burst Factor

#1313 HOLDS 50' of 3/8" 1-wire
#1314 HOLDS 100' of 3/8" 1-wire
#1315 HOLDS 150' of 3/8" 1-wire
#1316 HOLDS 200' of 3/8" 1-wire
#1008 SWIVEL, FITS #1313 & 1314
#1001 SWIVEL, FITS #1315 & 1316
#1002 REPLACEMENT HANDLE

HOSETRACT REELS

- Self lubricating ABS bushing.
- Adjustable brake-adjust tensioner
- Heavy duty brass swivel
- 7-10 DAY BUILD TIME



M-SERIES POWDER COATED

#1861 100' 3/8" or 75' of 1/2"
#1856 250' 3/8" or 175' of 1/2"
#1858 350' 3/8" or 275' of 1/2"
#1859 450' 3/8" or 375' of 1/2"
#1860 550' 3/8" or 475' of 1/2"

TITAN FULL FRAME STACKABLE



#TI1-3012
12" - Powder Coat
#TI1-3018
18" - Powder Coat
#TI1-4312
12" - Aluminum
#TI1-4318
18" - Aluminum
#TI1-4012
12"- 1" Manifold holds 90' of 3/4"
#TI1-4018
18"- 1" Manifold holds 150' of 3/4"
#TI1-4022
22"- 1" Manifold holds 180' of 3/4"
#TI1-4028
28"- 1" Manifold holds 230' of 3/4"
#TI1-4812E
12" - Electric, Aluminum
• 7-10 DAY BUILD TIME

REEL TO MACHINE JUMPER HOSES

- Rated to 6000 PSI
- 1 Swivel End & 1 Fixed End



#1171	1"	#1181	11'
#1172	2'	#1182	12'
#1173	3'	#1183	13'
#1174	4'	#1184	14'
#1175	5'	#1185	15'
#1176	6'	#1186	16'
#1177	7'	#1187	17'
#1178	8'	#1188	18'
#1179	9'	#1189	19'
#1180	10'	#1190	20'

STACKABLE SERIES



#1948 250' 3/8 or 175' 1/2"
#1949 350' 3/8 or 275' 1/2"
#1950 450' 3/8 or 375' 1/2"
#1951 550' 3/8 or 475' 1/2"

STAINLESS STEEL

#1952 250' 3/8 or 175' 1/2"
#1953 350' 3/8 or 275' 1/2"
#1954 450' 3/8 or 375' 1/2"
#1955 550' 3/8 or 475' 1/2"

TITAN KITS



#TI1-KIT Optional Stacking Kit
#TI1-GUIDE Optional Hose Guide

HOSE REEL SWIVEL by: Super Swivel

- Manufactured by Super Swivel
- Rated to 5,000 PSI
- Includes Grease Fitting



#1463
• 3/8" FPT machine to reel hose
• 1/2" FPT connects it to the reel

#2331
• 1/2" FPT for machine to reel hose
• 1/2" FPT connects it to the reel

#1611 Repair Kit

ALLISON REEL SWIVEL

- Rated to 5,000 PSI
- 3/8" FPT for machine to reel hose
- 1/2" FPT that connects it to the reel



#1591 Swivel

STAINLESS REEL SWIVEL

- Rated to 4,100 PSI
- 3/8" FPT for machine to reel hose
- 1/2" FPT connects it to the reel



#1630 Swivel
#1629 Kit

A-R 1450 RPM Pumps for Belt Drive

PUMP	GPM	PSI	Check Valves	Regular Packings	Oil Seals	Req'd Gas HP
RW15	4.0	3500	E2864	E42171	E42170	13
RW21	5.5	3500	E2864	E42171	E42170	18
XWM2128	5.5	4100	E2780	E2278	E2781	21
XWM2623	6.9	3000	E2780	E2278	E2781	19
XWL4121	10.8	3000	E2780	E1853	E2781	30
XWL4215	11.1	2200	E2780	E1853	E2781	23
XWL5015	13.2	2200	E2780	E1853	E2781	27



A-R 1750 RPM Pumps for Gear Drive

PUMP	GPM	PSI	Check Valves	Regular Packings	Oil Seals	Req'd Gas HP
XWAM55G40	5.5	4000	E2780	E2278	E2781	20
XWAM7G40	7.0	4000	E2780	E2278	E2781	26
XWAM8G35	8.0	3500	E2780	E2278	E2781	26
XWA9G30	9.0	3000	E2780	E2783	E2781	25



COMET 1450 RPM Pumps for Belt Drive

PUMP	GPM	PSI	Check Valves	Regular Packings	KEVLAR Packings	Oil Seals	Req'd Gas HP
RW4040S	4.0	4000	50250025	50190673	50190710	50190126	15
RW4540S	4.5	4000	50250025	50190673	50190710	50190675	16
RW5040S	5.0	4000	50250025	50190673	50190710	50190675	18
RW5535S	5.5	3500	50250025	50190672	50190674	50190675	18
TW8036S	8.6	3600	50250020	50190646	50190662	50190644	28
TW11025S	11.0	2500	50250020	50190647	50190663	50190644	25



COMET 1750 RPM Pumps for Gear Drive

PUMP	GPM	PSI	Check Valves	Regular Packings	KEVLAR Packings	Oil Seals	Req'd Gas HP
RWS6040S	6.0	4000	50250025	50190673	50190710	50190675	22
TWS8035S	8.6	3500	50250020	50190646	50190662	50190644	28
TWS10030S	11.0	3000	50250020	50190646	50190662	50190644	30
TWS13020S	13.0	2000	50250020	50190647	50190663	50190644	24



GENERAL 1450 RPM Pumps for Belt Drive

PUMP	GPM	PSI	Check Valves	Packings	Oil Seals	Req'd Gas HP
TS-2021	5.5	3500	K01	K08	K02	18
TSF-2019	6.3	3600	K169	K170	K02	21
TSF-2021	7.0	3600	K169	K170	K02	23
TSF-2219	7.7	3000	K169	K172	K02	21
TSF-2221	8.5	3000	K169	K172	K02	24
TSF-2421	10.0	3000	K169	K181	K02	28

DIRECT DRIVE PUMPS BOLT TO GAS ENGINES THAT HAVE 1" SOLID SHAFTS

A-R - 3400 RPM DIRECT DRIVE PUMPS

PUMP	GPM	PSI	Check Valves	Regular Packings	Oil Seals	Req'd Gas HP
RKV4G40	4.0	4000	AR1828	AR1857	AR1856	15
RKV55G40	5.5	4000	AR1828	AR1857	AR1856	19



COMET - 3400 RPM DIRECT DRIVE PUMPS

PUMP	GPM	PSI	Check Valves	Regular Packings	Oil Seals	Req'd Gas HP
ZWD4040G	4.0	4000	50250011	50190064	50190065	15
HWD5540G	5.5	4000	50250011	50190631	50190045	19



GENERAL - 3400 RPM DIRECT DRIVE PUMPS

PUMP	GPM	PSI	Check Valves	Packings	Oil Seals	Req'd Gas HP
EZ4040G	4.0	4000	K123	K153	K23	15



Voted the Industry's BEST Technical Web Site!

Place your order at www.envirospec.com



33% SUPER SUDS SUCKER

The industry's #1 selling chemical injector

- Draws Chemical with 300' of HP hose
- For machines from 2 GPM to 10 GPM

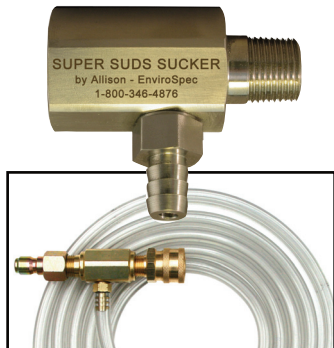

#1964 Injector
#1963 Ready-to-go injector

27% SUDS SUCKER

- Ready-To-Go injectors come with Quick Connects, filter & chem line
- All come with Ceramic Ball



Ready-To-Go
#1442 2-5 GPM, Non-Adj.
#1444 5-8 GPM, Non-Adj.
#1447 2-5 GPM, Adj.
#1449 5-8 GPM, Adj.

Injector Only (shown)
#1441 2-5 GPM, Non-Adj.
#1443 5-8 GPM, Non-Adj.
#1446 2-5 GPM, Adj.
#1448 5-8 GPM, Adj.

24% SUDS SUCKER

- Includes Ceramic Chlorine/Acid Ball



#1511 2-5 GPM, Non-Adj.
#1512 5-8 GPM, Non-Adj.

LAFFERTY FOAM TURBINE

- The New Allison Foam Turbine develops an 'aerated' wet foam. It has a detachable spray nozzle that once removed will provide you with a 0° nozzle that reaches up to 30'.
- Comes standard with an 'aerating' chemical injector. One barb goes to chemical and the other barb is used to induce additional air into the Turbine when more foam is required.

Injector installs on discharge side of machine

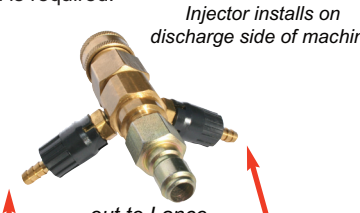

...out to Lance

One side to Chemical
The other side for additional air

Attach Turbine to end of the lance



#7500 Foam Turbine and aerating injector

27% - 2 in 1 SUDS SUCKER

- When one stops working close off that side - move the chem pick-up line to the other barb and you are off and washing again!



QC Plug & Coupler Sold Separately

Adjustable
#1736 Adjustable, 2-5
#1738 Adjustable, 5-8

27% STAINLESS SUDS SUCKER

- Ready-To-Go injectors come with Quick Connects, filter & chem line
- All come with Ceramic Ball



Ready-To-Go
#2075 3-5 GPM Non-Adj.
#2076 5-8 GPM Non-Adj.
#2077 3-5 GPM Adj.
#2078 5-8 GPM Adj.

Injector Only (shown)
#1140 2-5 GPM, Non-Adj.
#1141 5-8 GPM, Non-Adj.
#1142 2-5 GPM, Adjustable
#1143 5-8 GPM, Adjustable

- Use this injector when you are either pulling 2 chems at the same time (maybe bleach & soap) or connect together for max chem draw.



NON-ADJUSTABLE
#1737 2-5 GPM, Non-Adj.
#1739 5-8 GPM, Non-Adj.

FOAM CANNON

- Attaches to end of wand
- Throws a thick foam
- Works on units up to 6.6 GPM
- Rated for 3,000 PSI
- Order with or without bottle.



#1273 With Bottle
#1273-N Without Bottle

15% ROBO-CHEM

- Made by InterPump



#1135 2.2-4.0 GPM, Adjustable
#1136 4.0-5.6 GPM, Adjustable
#1137 5.6-10.9 GPM, Adjustable

ALLISON 'BANSHEE' CHEM-SHOOTER

- The Allison Chem Shooter Long Distance Chemical Inj. attaches to the end of the lance.
- Includes 3-each high impact laser nozzles for both distance and high volume chemical.
- Fully adjustable for 'waste-free' chemical application.
- Material: Stainless Steel body with Chlorine Ball.
- Includes 100' of clear chemical line & premium chemical filter.



HIGH IMPACT NOZZLES
Set includes: 0040, 50 & 60

#BCS58 3-10 GPM - Includes Injector & Noz. Set
#5555 Nozzle Set only

PREMIUM CHEM FILTER

- Stainless Steel & Brass Construction
- More actual filter area than most
- Has removable check ball



#1153

STAINLESS CHEM FILTER

- With check ball
- About 1/2 the size of 1153 & 1152



#1149

ALLISON M-16 VARIABLE THRUSTER NOZZLE

Reaches 3-4 stories from the safety of the ground!

Want to go even higher than 3 stories? Simply connect the thruster to a Telescoping Lance! Then throw up to 5 stories high!

- Push for Fully Adjustable Soap from 0° to 65°
- Pull Back for Adjustable High Pressure from 0° to 65°

Comes with 50' of Chemical Line & Premium Filter

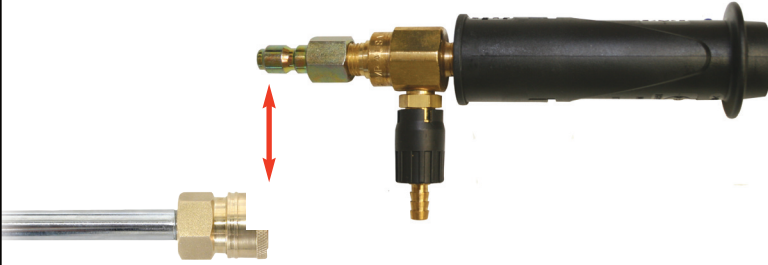

ATTACHES TO END OF A LANCE

#1992 3.5 Nozzle
#1993 4.0 Nozzle
#1994 4.5 Nozzle
#1995 5.0 Nozzle
#1996 5.5 Nozzle
#1997 6.0 Nozzle
#1998 6.5 Nozzle
#1999 7.0 Nozzle
#2000 8.0 Nozzle

PLASTIC CHEM FILTER

- Red Poly Filter. without check ball
- Not recommended for acids



#1152

ECONO CHEM FILTER



#1150 With check ball
#1151 Without check ball

ALLISON CHEM INDUCTION SYSTEM

TRIPPLE YOUR CHEMICAL DRAW EVEN WITH 500' OF PRESSURE HOSE

- Allison Chem Induction Pump #1671
- Includes Super Suds Sucker Injector
- Includes Chem Shooters
- Works on 2-10 GPM Systems

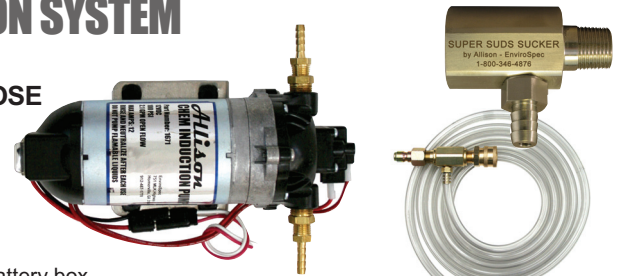

#2071 Complete System
#2071X Optional Hand Carry Frame with battery box

Optional frame with battery box Limited Qty's

Voted the Industry's BEST Technical Web Site!

Place your order at www.envirospec.com



PA GEAR BOX Dual Bearing

• Gear Boxes / Reducers are always better mounted on a 1750 RPM pump.

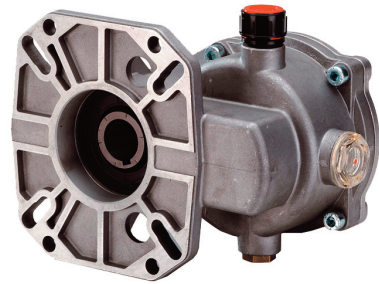

- #1028-181 for 1" shaft 13-18 HP
- #1028-241 for 1" shaft for 18-24 HP
- #1028-242 for 1-1/8" shaft for 18-24 HP
- #1028-311 for 1-1/8" shaft for 30 HP

ALWAYS USE A
COGGED V-BELT



PULLEYS



- #1656 3.40
- #1659 3.90
- #1662 7.40
- #1663 8.40

PULLEY BUSHINGS



- | | | |
|-------|--------|-----------------|
| #1026 | 1.0" | For Power Plant |
| #1027 | 1-1/8" | For Power Plant |
| #1033 | 24mm | For Pumps |
| #1034 | 32mm | For Pumps |

12-VOLT PUMP CLUTCH

- Stops the pump when the gun is released.
- Pressure or flow switch is required.
- For engines up to 22 HP

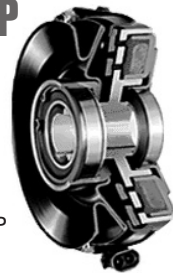

#9333

PULLEY PULLER

- I'll bet there have been times when you wish you had one of these!



#3342

PROPER PULLEY ALIGNMENT

Never over tighten v-belts. When installed you should be able to push the top of the belt down 1/2".

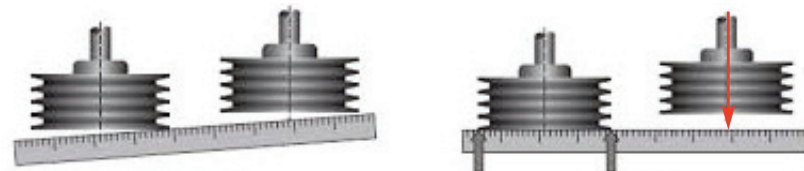

INCORRECT both must be flush on the straight-edge **CORRECT**

CHLORINE PUMPER

With 1 gun - 10 GPM
With 2 guns - 5 GPM each

Professional Roof Cleaners use a Cyclone more than any other method.



- #2777 Udor Chlorine Pump
- #CS7T 7 HP Kohler Engine
- #7555 Aluminum Base Plate
- #2339 1 150' Hose and Gun Assy.

HARD TO FIND FITTINGS Brass, Stainless, Super Hi-Pressure

WWW.ENVIROSPEC.COM



EVER FLOW PUMPS

- With Corrosion Resistant Viton Valves

- #EF1040 1.0 @ 40 PSI
- #EF2270 2.2 @ 70 PSI
- #EF3060 3.0 @ 60 PSI
- #EF4060 4.0 @ 60 PSI
- #EF1040 5.5 @ 60 PSI

Replacement parts at www.envirospec.com



CHEM LINE

- Reinforced Poly Tubing
- 250 PSI Working Pressure
- Resistant to Chems, Fuels, Solvents



- 1/4", 250 PSI
- #1161 1/4" x 100' Roll
- #1162 1/4" x 300' Roll

- 3/8", 250 PSI
- #1163 3/8" x 25' Roll
- #1164 3/8" x 50' Roll
- #1165 3/8" x 100' Roll
- #1166 3/8" x 300' Roll

- 1/2", 250 PSI
- #2217 1/2" X 100' Roll
- #2637 1/2" X 300' Roll

- 3/4", 250 PSI
- #2483 3/4" x 100' roll
- #2709 3/4" x 300' roll

- 1/4" Premium Clear Line
- #1167 100' Thick Wall
- #2199 100' Standard

TRIGGER JET CHEM GUN

- 350 PSI Gun, viton® seals with lance
- #1213 36.5" Poly Lance
- #1214 36.5" Stainless lance

- 750 PSI Gun Only
- #1212 Gun- Stainless Ball
- #1169 Gun-Ceramic Ball

- #1211 Replacement Cone Spray Nozzle



Guns have 1/2" Inlet so if you are using a...
...1/4" Chem Line Barb #1726
...3/8" Chem Line Barb #1727
...1/2" Chem Line Barb #1728

DOUBLE DUTY CYCLE CHLORINE PUMPER

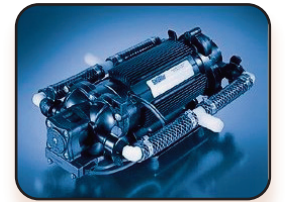

This Power Twin Shurflo system develops 6.25 GPM of open flow. Its rugged housing comes with dual manifolds, Viton® valves, Santoprene® diaphragm, 45 PSI demand switch, 1/2" MPT ports and high volume 5/8" barb ports.

Take all the performance and features of the time tested 2088 series, double it, and the result is this high flow Power Twin.

The new Power Twin is one of the most efficient high-flow self priming pumps available today.

#4111-035

SHURFLO PUMPS CHLORINE PUMPS



These special build pumps are specifically designed to handle chlorine as well as many other harsh chemicals.

12V SHURFLO with Viton Valves

- #1049 1.4 GPM, 60 PSI
- #1050 1.8 GPM, 100 PSI
- #1671 Allison Chem Induction Pump
- #1051 3.0 GPM, 45 PSI
- #1052 3.6 GPM, 45 PSI

115V SHURFLO with Premium Valves

- #1053 1.4 GPM, 60 PSI
- #1054 1.5 GPM, 150 PSI
- #1055 1.0 GPM, 60 PSI
- #1056 1.6 GPM, 100 PSI, /w-pwr cord

Repair Kits For SHURFLO Pumps

- #1040 By-Pass, Viton, All Models
- #1041 Diaphragm Kit, 8000 Series
- #1042 Pressure Switch, 8000, 60 PSI
- #1043 Pressure Switch, 8000, 100 PSI
- #1044 Pressure Switch, 2088, 45 PSI
- #1045 Diaphragm Kit, 2088 Series
- #1046 Check Valve - 8000 Series
- #1048 Check Valve - 2088 Series



PREMIUM STAINLESS STEEL HIGH PRESSURE NOZZLES



QUICK CONNECT NOZZLES **SCREW-IN, 1/4" MEG**

NOZ SIZE	0°	15°	25°	40°	NOZ SIZE	0°	15°	25°	40°
2.0	NOQS-0002	NOQS-1502	NOQS-2502	NOQS-4002	2.0	NOS-0002	NOS-1502	NOS-2502	NOS-4002
2.5	NOQS-0002.5	NOQS-1502.5	NOQS-2502.5	NOQS-4002.5	2.5	NOS-0002.5	NOS-1502.5	NOS-2502.5	NOS-4002.5
3.0	NOQS-0003	NOQS-1503	NOQS-2503	NOQS-4003	3.0	NOS-0003	NOS-1503	NOS-2503	NOS-4003
3.5	NOQS-0003.5	NOQS-1503.5	NOQS-2503.5	NOQS-4003.5	3.5	NOS-0003.5	NOS-1503.5	NOS-2503.5	NOS-4003.5
4.0	NOQS-0004	NOQS-1504	NOQS-2504	NOQS-4004	4.0	NOS-0004	NOS-1504	NOS-2504	NOS-4004
4.5	NOQS-0004.5	NOQS-1504.5	NOQS-2504.5	NOQS-4004.5	4.5	NOS-0004.5	NOS-1504.5	NOS-2504.5	NOS-4004.5
5.0	NOQS-0005	NOQS-1505	NOQS-2505	NOQS-4005	5.0	NOS-0005	NOS-1505	NOS-2505	NOS-4005
5.5	NOQS-0005.5	NOQS-1505.5	NOQS-2505.5	NOQS-4005.5	5.5	NOS-0005.5	NOS-1505.5	NOS-2505.5	NOS-4005.5
6.0	NOQS-0006	NOQS-1506	NOQS-2506	NOQS-4006	6.0	NOS-0006	NOS-1506	NOS-2506	NOS-4006
6.5	NOQS-0006.5	NOQS-1506.5	NOQS-2506.5	NOQS-4006.5	6.5	NOS-0006.5	NOS-1506.5	NOS-2506.5	NOS-4006.5
7.0	NOQS-0007	NOQS-1507	NOQS-2507	NOQS-4007	7.0	NOS-0007	NOS-1507	NOS-2507	NOS-4007
8.0	NOQS-0008	NOQS-1508	NOQS-2508	NOQS-4008	8.0	NOS-0008	NOS-1508	NOS-2508	NOS-4008
9.0	NOQS-0009	NOQS-1509	NOQS-2509	NOQS-4009	9.0	NOS-0009	NOS-1509	NOS-2509	NOS-4009
10	NOQS-0010	NOQS-1510	NOQS-2510	NOQS-4010	10	NOS-0010	NOS-1510	NOS-2510	NOS-4010

NOZZLE CART

GPM	500 PSI	1000 PSI	1500 PSI	2000 PSI	2500 PSI	3000 PSI	3500 PSI	4000 PSI	4500 PSI	5000 PSI	6000 PSI
2.0	5.5	4.0	3.5	3.0	2.5	2.5	2.0	2.0	2.0	2.0	1.5
2.5	7.0	5.0	4.0	3.5	3.0	3.0	2.5	2.5	2.5	2.0	2.0
3.0	8.5	6.0	5.0	4.0	4.0	3.5	3.0	3.0	3.0	2.5	2.5
3.5	10.0	7.0	5.5	5.0	4.5	4.0	3.5	3.5	3.5	3.0	3.0
4.0	12.0	8.0	6.5	5.5	5.0	4.5	4.5	4.0	4.0	3.5	3.5
4.5	13.0	9.0	7.5	6.5	5.5	5.0	5.0	4.5	4.0	4.0	3.5
5.0	15.0	10.0	8.0	7.0	6.5	6.0	5.5	5.0	4.5	4.5	4.0
5.5	20.0	11.0	9.0	8.0	7.0	6.5	6.0	5.5	5.0	5.0	4.5
6.0	20.0	12.0	10.0	8.5	7.5	7.0	6.5	6.0	5.5	5.5	5.0
6.5	20.0	13.0	11.0	9.0	8.0	7.5	7.0	6.5	6.0	6.0	5.5
7.0	20.0	15.0	12.0	10.0	9.0	8.0	7.5	7.0	6.5	6.5	5.5
8.0	30.0	20.0	13.0	12.0	10.0	9.0	8.5	8.0	7.5	7.0	6.5
9.0	30.0	20.0	15.0	13.0	12.0	11.0	10.0	9.0	8.5	8.0	7.5
10.0	30.0	20.0	20.0	15.0	13.0	12.0	11.0	10.0	10.0	9.0	8.0
12.0	40.0	30.0	20.0	20.0	15.0	15.0	13.0	12.0	12.0	11.0	10.0

FIND THE GPM OF YOUR PUMP (LEFT SIDE) - FIND THE PSI OF YOUR PUMP (RED) - FIND YOUR NOZZLE (WHITE)

BRASS SOAP NOZZLES

- The smaller the hole size the higher the pressure and the less your injector will draw.
- The larger the hole size the more chemical your injector will draw and the pressure will be less.



- #1870 Screw-In, 25°, 30 Hole Size
- #1872 Screw-In, 25°, 50 Hole Size
- #1873 Screw-In, 40°, 30 Hole Size
- #1874 Screw-In, 40°, 40 Hole Size
- #1876 Screw-In, 65°, 40 Hole Size
- #1877 Quick Connect, 65°, 40 Hole Size

STAINLESS SOAP NOZZLES



- #SSN-0030 - Screw-In, 00°, 30 hole size
- #SSN-0040 - Screw-In, 00°, 40 hole size
- #SSN-0050 - Screw-In, 00°, 50 hole size
- #SSN-0060 - Screw-In, 00°, 60 hole size
- #SSN-1512 - Screw-In, 15°, 15 hole size
- #SSN-1515 - Screw-In, 15°, 15 hole size
- #SSN-1520 - Screw-In, 15°, 20 hole size
- #SSN-1525 - Screw-In, 15°, 25 hole size
- #SSN-1530 - Screw-In, 15°, 30 hole size
- #SSN-1540 - Screw-In, 15°, 40 hole size
- #SSN-2512 - Screw-In, 25°, 12 hole size
- #SSN-2515 - Screw-In, 25°, 15 hole size
- #SSN-2520 - Screw-In, 25°, 20 hole size
- #SSN-2525 - Screw-In, 25°, 25 hole size
- #SSN-2530 - Screw-In, 25°, 30 hole size
- #SSN-2540 - Screw-In, 25°, 40 hole size
- #SSN-2550 - Screw-In, 25°, 50 hole size

NOZZLE CLEAN-OUT

- A 'must have' for every mobile washer!

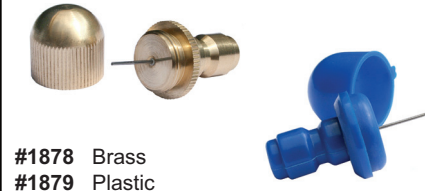

- #1878 Brass
- #1879 Plastic

CERAMIC NOZZLES
LAST 10 TIMES LONGER THAN STAINLESS NOZZLES



CERAMIC NOZZLE AFTER 50 HOURS



STAINLESS NOZZLE AFTER 50 HOURS

1/4" Threaded Ceramic Nozzles

NOZ.	'0' Degree	'15' Degree	'25' Degree	'40' Degree
3.0	NOC-0003	NOC-1503	NOC-2503	NOC-4003
3.5	NOC-1503.5	NOC-1503.5	NOC-2503.5	NOC-4003.5
4.0	NOC-0004	NOC-1504	NOC-2504	NOC-4004
4.5	NOC-0004.5	NOC-1504.5	NOC-2504.5	NOC-4004.5
5.0	NOC-0005	NOC-1505	NOC-2505	NOC-4005
5.5	NOC-0005.5	NOC-1505.5	NOC-2505.5	NOC-4005.5
6.0	NOC-0006	NOC-1506	NOC-2508	NOC-4006
7.0	NOC-0007	NOC-1507	NOC-2507	NOC-4007
8.0	NOC-0008	NOC-1508	NOC-2508	NOC-4008

Quick Connect Ceramic Nozzles

NOZ.	'0' Degree	'15' Degree	'25' Degree	'40' Degree
3.0	NOQC-0003	NOQC-1503	NOQC-2503	NOQC-4003
3.5	NOQC-0003.5	NOQC-1503.5	NOQC-2503.5	NOQC-4003.5
4.0	NOQC-0004	NOQC-1504	NOQC-2504	NOQC-4004
4.5	NOQC-0004.5	NOQC-1504.5	NOQC-2504.5	NOQC-4004.5
5.0	NOQC-0005	NOQC-1505	NOQC-2505	NOQC-4005
5.5	NOQC-0005.5	NOQC-1505.5	NOQC-2505.5	NOQC-4005.5
6.0	NOQC-0006	NOQC-1506	NOCS-2506	NOQC-4006
7.0	NOQC-0007	NOQC-1507	NOQC-2507	NOQC-4007
8.0	NOQC-0008	NOQC-1508	NOQC-2508	NOQC-4008



30' LONG RANGE SOAP NOZZLE



#PK852

CHEM SHOOTER NOZZLES

- Long Distance - High Impact Chem Nozzles
- Stand on the ground & apply up to 4-stories
- Nozzle sizes Included: 0040, 0050 & 0060

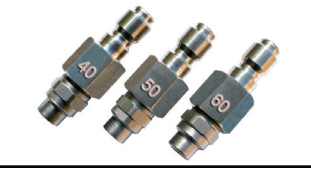

#5555

10% of everything you purchase one month can be applied to next months purchases.

Voted the Industry's BEST Technical Web Site!

Place your order at www.envirospec.com



TWIST TYPE

- You will love this one!
- Lance in Fig. 1
- Press. Noz. in Fig. 2 or 3
- Soap Noz. in Fig. 2 or 3
- Switch by 'twisting'

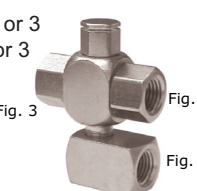

#1275

DUAL NOZZLE HOLDER

- Switch from Low to High by turning lance from side to side.



#1267 Holder w/Stainless Ball
#1269 Holder w/Ceramic Ball

TROMBONE

- Push for Hi-Pressure - Pull for Soap
- Lance attaches at Fig. 1
- Soap Noz. at Fig. 2
- Press Noz. at Fig. 3



#7775

SHOWER STYLE

- Pressure nozzle screws into the center
- When you want to go to low pressure soap twist the black housing.



#1274

MACHINE NOZZLE CADDY

- Bolts to the side of any pressure washer.



#1621 Complete Set-up
#1622 Extra Grommet

NOZZLE BOOT

- Use when working in close quarters. Screw on the end of the lance and then screw the nozzle into the boot housing.





#1271

SEWER NOZZLES

- PENETRATOR NOZZLE**
- #2080 1/8" NPT / 4.0 / 3 Back 1 Front
- #2081 1/8" NPT / 5.0 / 3 Back 1 Front
- #2082 1/8" NPT / 5.5 / 3 Back 1 Front
- #2083 1/8" NPT / 6.0 / 3 Back 1 Front
- #2084 1/4" NPT / 4.5 / 3 Back 1 Front
- #2085 1/4" NPT / 5.5 / 3 Back 1 Front
- #2086 1/4" NPT / 6.5 / 3 Back 1 Front
- #2087 1/4" NPT / 7.0 / 3 Back 1 Front
- #2088 1/4" NPT / 8.0 / 3 Back 1 Front
- #2094 1/4" NPT / 9.5 / 3 Back 1 Front
- #2089 1/4" NPT / 12.0 / 3 Back 1 Front
- #2090 3/8" NPT / 4.5 / 3 Back 1 Front
- #2091 3/8" NPT / 5.5 / 3 Back 1 Front
- #2092 3/8" NPT / 6.5 / 3 Back 1 Front
- #2093 3/8" NPT / 8.0 / 3 Back 1 Front

- ROTATING NOZZLES**
- #1760 1/8" NPT / 5.5 NOZZLE SIZE
- #1754 1/4" NPT / 5.5 NOZZLE SIZE
- #2282 1/4" NPT / 8.0 NOZZLE SIZE

ALLISON LASER DECK SURFACE SPINNERS

THE INDUSTRY'S MOST POPULAR SPINNERS

- ABS Plastic Deck with 2-nozzle bar*
- Most durable swivel with grease fitting
- Rated to 4,500 PSI
- Rated to 12 GPM



12" DECKS ARE GREAT FOR:

- Pool Patios
- Tile Walls and Floors
- Small Decks and Concrete Pads
- Brick Walls & Roofs

20" DECKS ARE GREAT FOR:

- Pool Patios
- Sidewalks
- Garage Floors
- Large Decks
- Concrete Pads
- Dumpster Areas
- Roofs

#1850 12" Laser Deck
#1853 20" Laser Deck

1/4" MEG Nozzles sold separately

Nozzle Sizing:
Whatever size nozzle you are presently using - split that number in 1/2. Ex: If you are using a #6 nozzle on your gun assembly you will need to use 2-each #3's for your Laser Deck.

TANK to EQUIPMENT

NON-CRUSHABLE 'RIBBED' HOSE

Will not collapse in hot weather or when you accidentally set something heavy on it.



#4530 3/4"
#4531 1.0"
#4532 1-1/4"

REEL & CHEM HOSE

WILL NOT KINK OR COLLAPSE!

800 PSI Working Pressure. Great By-pass hose for Unloaders. Great for Hose Reels & Chlorine Pumps.



#3399 3/8" ID
#3400 1/2" ID
#3401 3/4" ID

FOUL WEATHER GEAR

WWW.ENVIROSPEC.COM



3000 PSI CARBON STEEL



#1303 3/8" FPT x FPT

3000 PSI PLATED STEEL



#1669 3/8"
#1670 1/2"

MINI VALVES

- 200 PSI

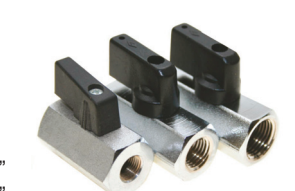

#1461 1/8"
#1464 3/8"
#1465 1/2"

ULTRA HIGH PRESSURE



#1304 1/4" 7500 PSI
#1305 3/8" 7500 PSI
#1306 1/2" 5000 PSI

3-WAY ULTRA 'H-P'



#1467 1/4" 7500 PSI
#1468 3/8" 7500 PSI
#1469 1/2" 5000 PSI

LONG HANDLE MINI'S

- 200 PSI



#LH14BV 1/4" FPT x FPT - Premium
#LH38BV 3/8" FPT x FPT - Premium
#LH12BV 1/2" FPT x FPT - Premium

5000 PSI STAINLESS



#1666 1/4"
#1667 3/8"
#1668 1/2"

STAINLESS STEEL

- All FPT x FPT
- 2,000 PSI

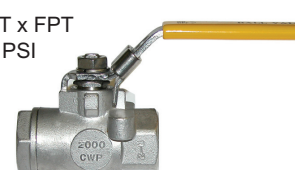

#538 3/8" #540 3/4"
#539 1/2" #541 1.0"

CHEM THROTTLE VALVE

- Use on 1/4" 3-way ball valve #1308 below to throttle chemicals into the injector
- Brass - 220 PSI



#1307

3-WAY CHEM VALVE

- Use with Chem Throttle #1307 to switch from one chemical to another
- 1/4" Brass - 220 PSI



#1308

3-WAY LOW PRESSURE

- 600 PSI



#4535

TEFLON TAPE



#1651 Tape, Teflon, 520' x 1/2"
#2151 USA Premium Teflon, 520' x 1/2"

CHEM METERING VALVE

- 1/4" FPT x FPT
- Meter Chems or divert water to create steam



#2447

THREAD LOCKER

- Medium strength is preferred with pressure wash equipment



#1057 Medium Thread Locker
#1058 High Strength Thread Locker

ELECTRICAL TAPE



#1601 Tape, Electrical, 3/4" X 60', UL



THERMOSTATS

PROBE STYLE (most popular)

- Allison Series is our most popular
- The closest 'dead-band' response of all the thermostats listed here.
- Re-engages the burner with 8° temp drop



- #C160-44 Shuts burner off at 160°
- #C200-44 Shuts burner off at 200°

ADJUSTABLE PANEL MOUNT

- The insertion 'bulb' is rated to 3,500 PSI



- #1422 to 302°
- #1425 to 194°

IN-LINE THERMOSTAT

- Mounts on discharge side of heating coil
- Temp range from 60 to 230 degrees



#1426

FUEL FILTERS

- Removes water from fuel

- #1794 M-T-M (#1 seller)
- #1793 Element
- #1419 Racor
- #1420 Element



BURNER NOZZLES

- #1379 1.00 GPH
- #1380 1.25 GPH
- #1381 1.50 GPH
- #1382 1.75 GPH
- #1383 2.00 GPH
- #1384 2.25 GPH
- #1385 2.50 GPH
- #1386 2.75 GPH
- #1387 3.00 GPH



12-V BURNER RELAY

- Takes the shock out of 12 Volts
- Extends the life of the transformer
- Handles up to 80 AMPS



#2039

SOOT REMOVER

- Add to burner fuel to stop smoking & keep coils clean



- #6998 Pint
- #6999 Quart

BURNER TEST LIGHTS



- #5796 Flow Switch - Blue - 12V
- #5797 Thermostat - Red - 12V
- #5798 Hi-Limit - Yellow - 12V
- #5790 Flow Switch - Blue - 110V
- #5791 Thermostat - Red - 110V
- #5792 Hi-Limit - Yellow - 110V

MOUNTING BLOCK

- Remote mount the fuel filter and take the load off the fuel pump.



#1115

BURNER MOTORS

- Fits Beckett & Wayne Burners

- #1410 115V (2456U)
- #1411 115V (2900U)
- #1412 13.5V (21699U)
- #1413 12V (21539)
- #1414 115/240V (2134)
- #1415 1/4 240V (2899)

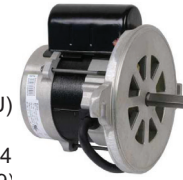

IGNITOR TESTER

- If you own a hot water pressure washer - you must own one of these. Diagnosis burner problems in 5-seconds rather than 2-hours.

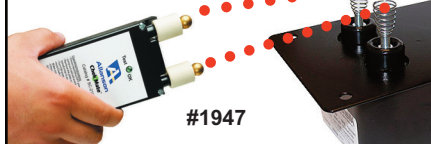

#1947

HI-LIMIT SWITCH

- Shuts down fuel flow if water reaches 230 degrees. Mounts on coil outlet.



#1107

BECKETT POWER WASH BURNERS

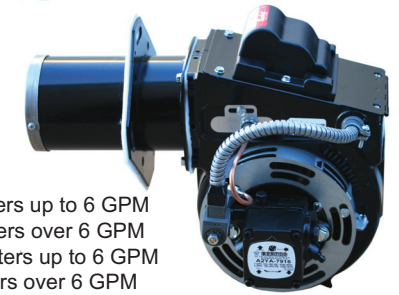

PERFORMANCE BEYOND EXPECTATION

- #1390 12 Volt ADC for heaters up to 6 GPM
- #1391 12 Volt SDC for heaters over 6 GPM
- #1393 115 Volt AFG for heaters up to 6 GPM
- #1394 115 Volt SF for heaters over 6 GPM

IGNITERS TRANSFORMERS

- #1404C - 51778U/5218303U 12V igniter SDC Beckett with CAD
- #1405 - 51777U / 5218301U 12V igniter - Beckett or Wayne 12V, no CAD
- #1405C - 51776U / 5218301U 12 V igniter ADC Beckett with CAD
- #1406 - 5878U Transformer for 120V 'A' Beckett, old style
- #1408 - 2357 Transformer for 230V 'S' Beckett
- #1409 - 51824U Transformer for 120V 'A' Beckett - see 1406 for old style
- #1376 - 23101-E Transformer, Wayne, 120V, Side Hinge
- #1378 - 23103-E Transformer, Wayne, 230V, Side Hinge

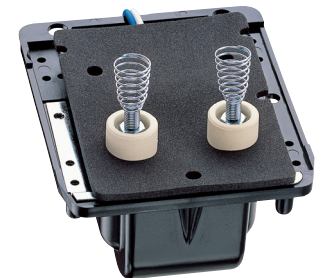

COIL INSULATION

- 1" Thick x 24" Wide x 5' Long
- Enough for One Coil



#1037

BURNER - Misc.

ON/OFF SWITCH

- Rated to 50 AMPS @ 12 Volts

#1388



COIL BLOW-OUT VALVE

- Open the trigger gun and induct air into the valve to push water out and keep machine from freezing.

#1074



ELECTRODE SETTING TOOL

#4501



TUNE-UP KITS



- #1416 Beckett
- #1389 Wayne

FUEL PRESSURE GAUGE

- 200 PSI - Includes connector
- Pressure must be set to 150 PSI
- Easy Installation

- A MUST HAVE TOOL



#1128

REPLACEMENT COILS

LOST A COIL? We have coils for any machine at the industry's best price!



800-346-4876

VAC SWITCH

- Mounts on the inlet side of the pump



- #1373 For Gas Engines
- #1374 For Electric Motors

PRESSURE SWITCH



- #1370 3,650 PSI, 1/4" MPT
- #1371 3,650 PSI, 3/8" MPT
- #1372 6,500 PSI, 1/4" MPT

FUEL PUMPS and SOLENOIDS

- #1399 SunTec Pump, A2VA7116
- #1400 SunTec Pump, A1VA7112
- #1402 SunTec Pump, A1YA7912
- #1397 Beckett Pump, 115V w/Solenoid
- #1398 Beckett Pump, 12V w/Solenoid
- #1396 Repair Kit for 12V Solenoid
- #1395 Repair Kit for 115V Solenoid



- Solenoids fit Beckett & Suntec
- #1392 for 220 Volt
- #1418 for 120 Volt
- #1417 for 12 Volt

FLOW SWITCH



1367 & 1368



1369

2272

- #1367 VMO*, 4-12 GPM
- #1368 VHM**, 4-12 GPM
- #1369 VHM**, TMT, 12 GPM Premium
- #2272 VHM**, 4-18 GPM

- * Vertical Mount Only
- ** Vertical or Horizontal Mount



PREMIUM GAS FILTER

- 1/4" In/Out



#7000

UNIVERSAL KEY SWITCH

- Fits All Engines



#1430 ON / OFF / START

KEY WAY STOCK

- For mounting pulleys & gears to eng. shafts
- Case Hardened for higher torques



#3776 For 3/4" Shaft

PREMIUM FUEL LINE

- 1/4" Thick Wall
- For Gas or Diesel



#1196

BATTERY BOXES

- Tie-down Hardware
- Marine Grade



#1690 Large (Std. Size)
#4690 Small (U1 Tractor)

BATTERY TERMINALS

- Heavy Duty - Lead Construction



#1825

24-GALLON FUEL TANKS

- MOLLER MARINE GRADE FUEL TANKS
- Includes Mounting Hardware & Cap
- 31.5L x 17W x 11H

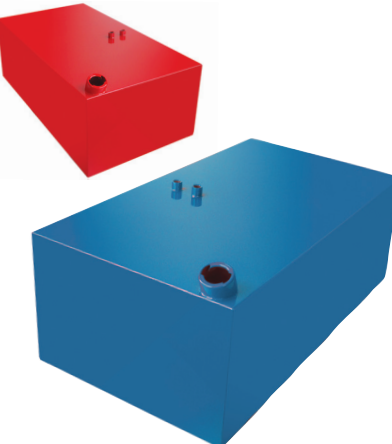

#9400 RED 24 Gal. Tank for GAS ONLY
#9401 BLUE 24 Gal. Tank for Diesel ONLY

6-GALLON FUEL TANK

- Comes with 5/16 Fuel Line Quick Connect
- Includes 1/4" x 5/16" reducing barb
- For Large Cart Equipment



EPA APPROVED
#4121

REMOTE THROTTLE CABLE

- Remote mounting of engine throttle



#1991

SLUDGE SUCKER

- Place the black foot into the flooded area. Connect the pressure washer hose to the foot. Stretch out the blue discharge hose and pull the trigger on the pressure washer and watch the flooded area disappear.



#1348

WIRE LOOM

- Hide and protect unsightly wires & cables



#4455 1/4" x 8'
#4457 1/2" x 8'
#4458 5/8" x 8'

SAND BLAST KIT

- INDUSTRIAL SERIES
- 5500 PSI / to 10 GPM
- Mount to end of lance, place pick-up probe in '00' grade sand and pull the trigger

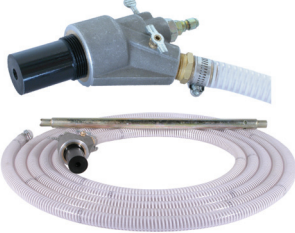

#1288

- PROFESSIONAL SERIES
- 4500 PSI / to 8 GPM



#4191 4.0 Noz
#4192 6.0 Noz

KOHLER ENGINES - 'BORN TO RUN'

GAS ENGINES - Mufflers & Shipping Included



#ICS7T Kohler, 7 HP, 3/4" Shaft
#KO14 Kohler, 14 HP, 1" Shaft
#K014ES Kohler, E-Start, 14 HP, 1" Shaft
#1829 Kohler, 18 HP, 15 Amp, 1" Shaft
#1732 Vanguard, 18 HP, 20 Amp, 1" Shaft
#19EFI Kohler EFI, 19 HP, 20 Amp, 1-1/8" Shaft
#19EFI-ID* Kohler EFI, 19 HP, 25 Amp, 1-1/8" Shaft with Allison Engine Idle Down
#1830 Kohler, 22 HP, 20 Amp, 1-1/8" Shaft
#1831 Kohler, 25 HP, 20 Amp, 1-1/8" Shaft
#25EFI Kohler, 25 HP, 20 Amp, 1-1/8" Shaft
#29EFI Kohler EFI, 29 HP, 25 Amp, 1-1/8" Shaft
#29EFI-ID* Kohler EFI, 29 HP, 25 Amp, 1-1/8" Shaft with Allison Engine Idle Down
#1834 Kohler, 30 HP, 25 Amp, 1-1/8" Shaft
#1836 Kohler, 40 HP, 25 Amp, 1-7/16" Shaft

*Electronic Idle Down require the installation of a Flow type or Soft Touch Unloader. With this engine there are no manual throttle controls. Everything is done electronically.

MUFFLERS

#1279 Kohler, 18-22 HP, Top Mount, Oil Filter Side
#1280 Kohler, 18-22 HP, Top Mount, Starter Side
#1282 Kohler, 18-22 HP, Low Mount, Oil Filter Side
#1281 Kohler, 18-22 HP, Low Mount, Starter Side
#1283 Kohler, 25-30 HP, Top Mount, Oil Filter Side
#1284 Kohler, 25-30 HP, Top Mount, Starter Side
#1286 Kohler, 25-27 HP, Low Mount Oil Filter Side
#1285 Kohler, 25-27 HP, Low Mount Starter Side
#1712 Kohler, 40 HP, Opposite Starter Side
#1713 Kohler, 40 HP, Starter Side

EFI MUFFLERS

#1714 Kohler, 19, 25 & 29 HP Oil Filter Side
#1715 Kohler, 19, 25 & 29 HP Starter Side



KOHLER MAINTENANCE

Kits Includes:

- 2 Quarts of Oil, Oil Filter, Air Filter, Pre-Cleaner, Fuel Filter & 2 Spark Plugs



#6440 KIT Fits 18 HP Kohler
#6441 KIT Fits all Kohlers 22 - 30 HP

#1837 Long oil filter / Pro Series
#1838 Short oil filter / Pro Series
#1839 Fuel filter
#1840 Air filter/Pre-Cleaner fits CH-25 & 27
#1841 Pre-cleaner fits CH-25 & CH-27
#1842 Air Filter/Pre-Cleaner, CH-18, 20, 22
#1843 Pre-cleaner fits CH-18, 20 & 22

HONDA PREMIUM REPAIR PARTS

#30334 Air Cleaner Cover, GX340, 390
#1613 Air Filter GC160
#1614 Air Filter GX160-200
#1615 Air Filter GX240,-270
#1616 Air Filter GX340-390
#49915 Carburetor, GX340
#50637 Carburetor, GX390
#49912 Carburetor Float, GX340-390
#49997 Carb. Needle Valve, GX240/270/340/390
Fuel Cap, GX390
#07319 Fuel Tank, GX160
#07600 Fuel Tank, GX240
#07601 Fuel Tank, GX390
#1129 Gas Cap
#50418 Gasket Set, Complete, GX340
#50419 Gasket Set, Complete, GX390
#33521 Ign. Coil, GX240, 270, 340 & 390
#35036 Muffler w/Shield, GX340-390
#35043 Muffler Heat Shield Only, GX240
#35044 Muffler Shield Only, GX340-390
#35045 Muffler Pipe, GX240, 340, 390
#33542 Oil Alert Diode Assy, GX160-390
#33540 Oil Alert Sensor, GX240-390
#1620 Oil Dip Stick, GC135 & GX200
#1617 Oil Filters, GX620 thru 690
#33013 On/Off Switch
#31910 Recoil Starter Handle
#31060 Recoil Starter Ass., GX340-390-610-620
#31059 Recoil Starter Assy. (Old Style), GX340
#31049 Recoil Starter Assy., GX240-270
#1618 Spark Plug, GC/GX 4HP thru 13 HP

TINY TACH/HOUR METER

- Always know what your engine rpm is
- Helps to keep up with oil changes



#1429 For Gas Engines
#1429EFI Fits Kohler EFI Engines Only
#3407 For Diesel Engines

VANGUARD FILTERS



#1733 Pre-cleaner
#1734 Oil Filter
#1735 Air Filter

STARTER SOLENOID

- Universal - Fits All Gas Engines



#1427

QUICK DRAIN OIL PLUG

- For Engines & Pumps



#1428 Will Not Fit Honda or 7 & 14 Kohler

Voted the Industry's BEST Technical Web Site!

VERTICAL HOT WATER HEATERS

• These heaters are much *less efficient* than horizontal heaters.



• These are 'space saver' heaters and are not recommended for open trailers.
 # 9817 12V Beckett up to 6 GPM
 # 9815 115V Beckett up to 6 GPM

HORIZONTAL HOT WATER HEATERS

• Horizontal heaters are the most efficient and easiest to work on heaters in the industry.



9812 12V Beckett up to 6 GPM
 # 9898 12V Beckett up to 12 GPM
 # 9899 115V Beckett up to 12 GPM

PANEL MOUNT FLOW METERS

• Accuracy: ± 4% FS
 • For the precise metering of acids and detergents on power wash equipment
 • No more guess work! Dial it in to where your products work best.
 • Mounts on machine between chemical supply and the chemical injector.
 • Handle temps up to 176°
 • Acrylic Body Material
 • Stainless 316L Float Ball
 • Maximum Pressure: 150 PSI
 • 6.5" Long
 • 1/4" FPT Connections

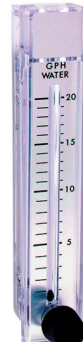

FM0020 For Chemical flows between 0-2 GPM
 # FM0050 For Chemical flows between 0-5 GPM

Place your order at www.envirospec.com



HAND CARRY FRAME

• The larger frame is great for engines to 7 HP and the smaller is best used for electric motors and ShurFlo Pump Set-ups.
 • Great frame for building a Chlorine Pumper using the Udor chlorine pump and the Kohler 7 HP engine.



#6704 Handle height from base - 10.5"
 #6705 Handle height from base - 15.0"

Allison IRON HORSE COLD WATER SUPER SKID FRAME

• Aircraft Aluminum
 • 6 Vibration Isolators
 • Pre-drilled for Honda, Kohler, & Vanguard
 • Includes aluminum reel that holds 250' of 3/8"

#8100

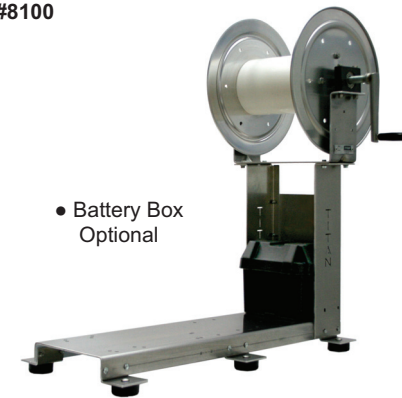

• Battery Box Optional



Shown complete for illustration purposes only.

EXHAUST HOOD CLEANING EQUIPMENT

• #9830 COMMERCIAL SERIES with 180° Hot Seals
 • #AIH-C INDUSTRIAL CART SERIES with Kevlar / 210° Seals
 • #AIH-F INDUSTRIAL FRAME SERIES with Kevlar / 210° Seals



#9830

KOHLER 25 HP DIESEL 10.0 GPM @ 3,000 PSI 8.6 GPM @ 3,600 PSI

KD-1030 10.0 GPM Dual Gun System
 # KD-8636 8.6 GPM Dual Gun System

Other Pkgs. Available - Call!

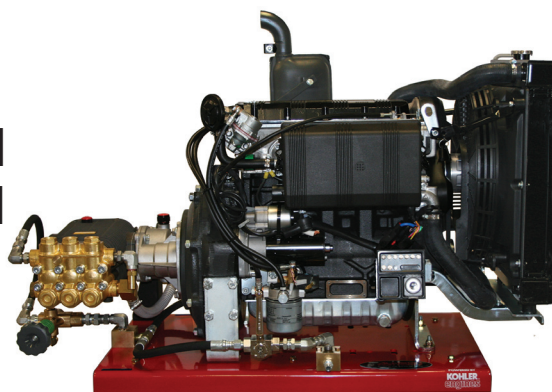

VALUE PAK ASSEMBLY REQUIRED

• Comes complete with Pumps are Gear Drive, pto, throttle cable, tachometer, unloader, mounting blocks, ball valves, base plate, muffler and safety valves. If you order this you will save thousands but you must realize we can't help you by phone.

Cust Pays Shipping
 Nuts & Bolts not included

Allison IRON HORSE 18-30 HP PRESSURE WASHER CARTS

These carts are the toughest pressure washer carts in the industry. They include:

- 30" x 1/4" Aircraft Aluminum
- Premium tires
- Nozzle holders



#9901

Allison IRON HORSE 14-30 HP PRESSURE WASHER BASE PLATES

These carts are the toughest pressure washer carts in the industry and include:

- Aircraft Aluminum
- 6-each Vibration Isolators



#7556 35.5L x 10"W & 6 Vibration Isolators
 Shown above with reel stand & reel

CART PARTS

- #1778 10" Foam Filled Tire
- #1773 13" Pneumatic Tire for 3/4" Axle
- #1779 13" Foam Filled Tire for 3/4" Axle
- #1774 Axle Cap for 5/8" Axle
- #1775 Axle Cap for 3/4" Axle
- #1776 Rubber Foot, Round

SAFETY PRESSURE RELIEF VALVE

• Rated to 6000 PSI/12 GPM



#1123 Standard
 #0534 Premium
 #1126 Valve w/Barb

THERMAL PROTECTOR

• Installs on inlet side of pump and allows cold water to enter if the gun is left in by-pass to long.



#1076 1/2" End Discharge
 #5575 3/8" End Discharge
 #1062 3/8" Side Discharge

EASY START VALVE

• For 'rope-start' pressure washers
 • Installs on high-pressure side of pump and relieves back-pressure on pump.



#1124

#7555 15.75"L x 10"W & 4 Vibration Isolators



#7503

(Easy assembly required)

10% of everything you purchase one month can be applied to next months purchases.

26 Unless noted otherwise all WEB orders of \$150.00 & up will ship FREE to the lower 48 States.

27

Largo Pressure Washers

**BEST EQUIPMENT & BEST PRICES
ON HOT WATER SUPER SKIDS**

STANDARD FEATURES:

- Powder Coated EHD Frame
- High Limit Over Temp Protection
- Sch. 80 Black Pipe Heating Coil
- Color Coded Spray Tips
- Poly Battery Box
- Belt Driven General Pump
- Hour Meter
- 2500 Watt Generator - G Models
- Thermal By-Pass Protection
- 10 Gal. Diesel Tank
- 7 Gal EPA approved Gas Tank
- Beckett Burner
- Pressure Relief Valve
- Heavy Duty Unloader Valve
- 12VDC Burner
- Requires Group 24 Deep Cycle Battery (Not Included)



Both shown with optional stainless add-ons

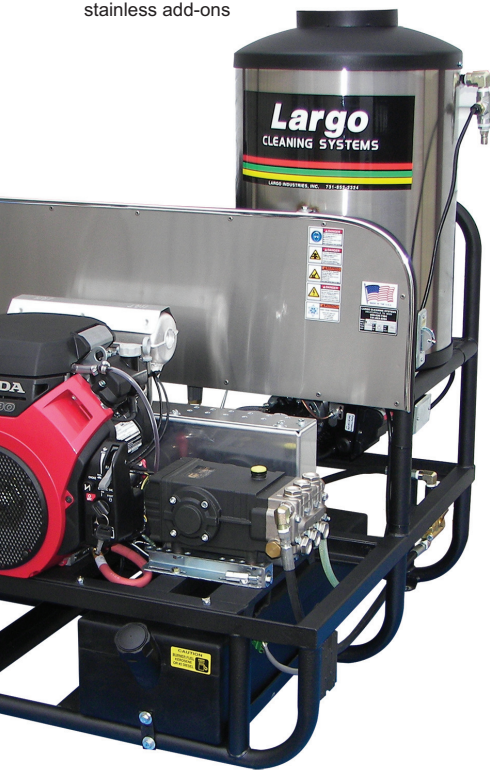

HORIZONTAL COIL SYSTEMS

MODEL	GPM	PSI	HP	ENGINE	BURNER	SHIPPING WEIGHT	DIMENSIONS
E5635HZV	5.6	3500	18	Vanguard	12VDC	780	42.5W x 41.5L x 50H
E5635HZHG	5.6	3000	GX630	Honda	115VAC	825	42.5W x 45.5L x 50H
E5630HZVG	5.6	3000	18	Vanguard	115VAC	825	42.5W x 45.5L x 50H
E8635HZH	8.6	3500	GX690	Honda	12VDC	810	42.5W x 45.5L x 50H
E8630HZHG	8.6	3000	GX690	Honda	115VAC	830	42.5W x 45.5L x 50H
E1030HZH	10.0	3000	GX690	Honda	12VDC	890	42.5W x 45.5L x 50H

VERTICAL COIL SYSTEMS

MODEL	GPM	PSI	HP	ENGINE	BURNER	SHIPPING WEIGHT	DIMENSIONS
E5635V	5.6	3500	18	Vanguard	12VDC	700	40.5W x 41.5L x 54H
E5630GV	5.6	3000	18	Vanguard	115VAC	730	40.5W x 41.5L x 54H
E5635HV	5.6	3500	GX630	Honda	12VDC	730	40.5W x 41.5L x 54H
E5630HGV	5.6	3500	GX630	Honda	115VAC	730	40.5W x 45.5L x 54H

RED PART NUMBERS indicate units with Winco Generators for 115VAC current.

Customer Pays Shipping on Pressure Washers

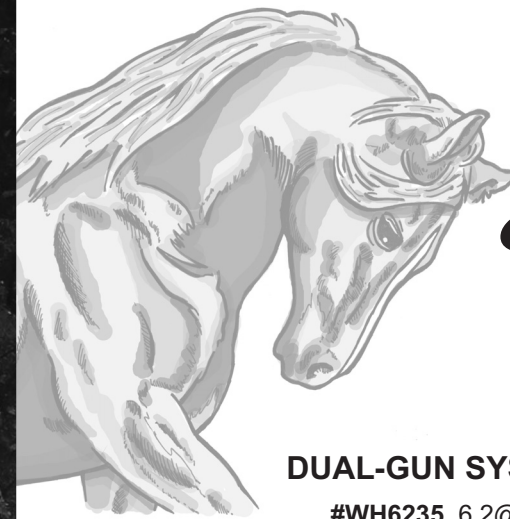

Allison WARHORSE PRESSURE WASHER

DUAL-GUN SYSTEMS:

- #WH6235 6.2@3,500
19 EFI KOHLER
- #WH8636 8.6@3,600
29 EFI KOHLER
- #WH1130 10.7@3,000
29 EFI KOHLER*
- #WH1325 13.0@2,500
29 EFI KOHLER*



I sold more jobs as a contractor simply because...

1. I looked like a **PROFESSIONAL** when I showed up in my nice **CLEAN** service vehicle wearing my **CLEAN** uniform with my name over the pocket and...

2. **THEY KNEW** I was a serious **PROFESSIONAL** when they saw my **EQUIPMENT** - especially since the last guy that showed up arrived in a '92 Hyundai Excel with a 'worn-out' pressure washer in the trunk.

Yes, all those guys I 'buted' heads with for 20 years as a contractor are doing something else now.

What will you be doing in 20 years?

Looking the part and having professional equipment will open the doors if it is your choice to remain in this industry.

John Allison, President
EnviroSpec

Customer Pays Shipping on Pressure Washers

AND WE PAY THE SHIPPING!

GENERAL PUMP

High Pressure Jetting Pumps

KF50MA SERIES MUD PUMP

7.7 to 28 GPM
1,300 to 1,500 PSI
Weighs 158 Lbs.
List \$9,500.00

Our Price
\$5,706.50



HF SERIES

8 to 20 GPM
4,000 to 8,700 PSI
Weighs 132 Lbs.
List \$9,800.00

Our Price
\$5876.88



MK SERIES

75.0 to 107.0GPM
2175 to 2900 PSI
Weighs 862 Lbs.
List \$30,632.00

Our Price
\$17,985.08



VF SERIES

3.3 to 6.0 GPM
11,600 to 21,750 PSI
Weighs 150 Lbs.
List \$20,066.00

Our Price
\$11,702.30

